

# BATTERY USER MANUAL

## FlexiBlock Battery

### 24V 50Ah Lite

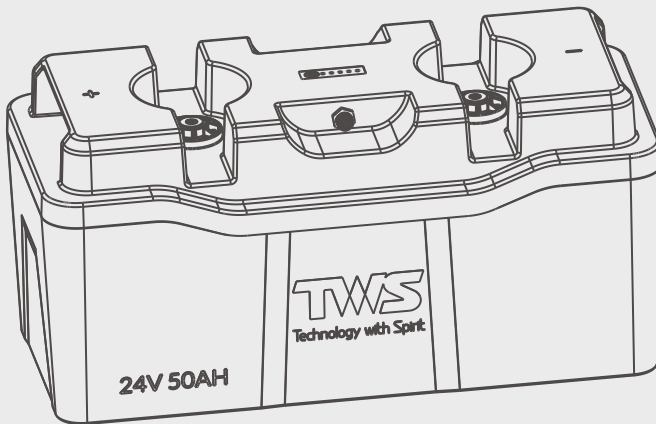

# Table of Contents

Introduction	01
What's In the Box	02
Read Before Installation	02
Battery Appearance	03
Battery Operation	04
• Check the Battery	04
• Battery Installation	04
• Connect Single Battery	04
• Connect Batteries in Parallel	05
• Connect Batteries in Series	08
• Select Appropriate Connection Cable	11
Battery SOC Table	11
Battery Management System	11
Self-Heating Function	11
Troubleshooting	12
Specifications	13
Battery Maintenance and Disposal	14
Frequently Asked Questions	15
Disclaimer	15

# Introduction

TWS FlexiBlock Battery 24V 50Ah Lite is equipped with multiple advanced technologies for motive and stationary applications.

## UltraSeal Tech

Rated IP67 water and dust proof, UltraSeal Tech is constructed for harsh.

## Ultra Safety with Intelligent BMS

Multiple advanced technologies ensure up to 20+ protections for consistent and stable battery performance, anytime and anywhere.

## Extremely Versatile In Series and In Parallel

- Easy integration can be placed both horizontally and vertically.
- Stackable blocks in multiple configurations expand systems up to 10.24 kWh.
- Suitable for entire portfolio of machines and market applications.

## Better Performance at Extreme Temperatures

LiFePO<sub>4</sub> ensures excellent discharge performance from -4°F(-20°C) ~ 131°F(55°C).

## Self-Heating Function (Optional)

The battery has a built-in self-heating function to warm up the battery at a low temperature for charging and discharging.

## Monitor with Bluetooth & APP (Optional)

The battery's real-time battery SOC, safe charging and diagnostic information can be monitored anytime and anywhere via Bluetooth and App.

## What's In the Box

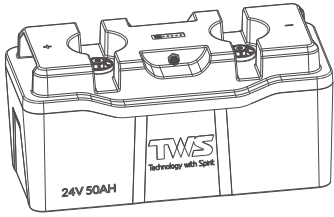

Battery

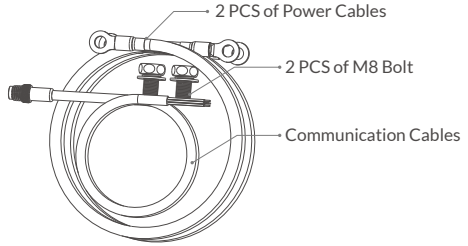

Accessories Set

\*Make sure that all accessories are complete and free of any signs of damage.

## Read Before Installation



HANDLE WITH CARE



DO NOT PRESSURE WASH OR SUBMERGE



CHARGE BATTERY BEFORE USE

WARNINGS	USE & CARE
<ul style="list-style-type: none"> <li>• DO NOT install or service this battery unless you are properly trained</li> <li>• Use only with components that have the same voltage and current rating as the battery</li> <li>• DO NOT touch or connect to the terminals unless the battery is manually turned off</li> <li>• DO NOT open or attempt to service the battery, there are no user-serviceable parts inside</li> </ul>	<ul style="list-style-type: none"> <li>• Do not overcharge or over-discharge the battery</li> <li>• Only charge the battery with a battery charger or charge controller that is compatible with lithium iron phosphate batteries</li> <li>• DO NOT pressure wash, submerge, or use chemical agents to clean your battery</li> <li>• Clean the battery using a damp cloth that does not include chemical agents</li> </ul>

# Battery Appearance

\*Prior to installing and configuring the battery, prepare the recommended tools, components, and accessories.

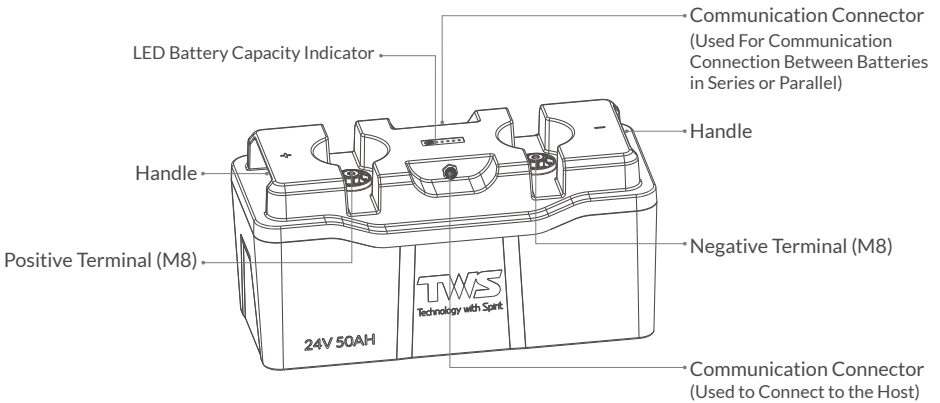
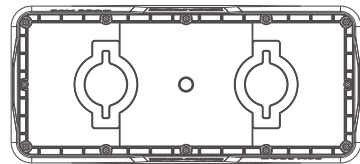
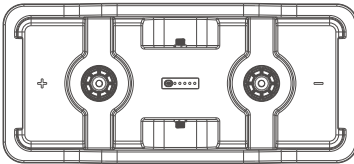
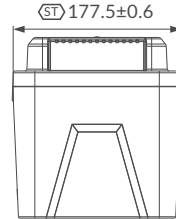
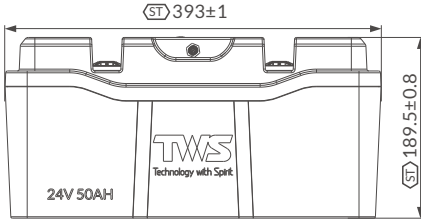

# Battery Operation

## Check the Battery

- After opening the battery package, first check the battery and accessories. If the battery is damaged or parts are missing, please contact the vendor.
- Make sure the electrical specifications of the battery are compatible with the relevant devices and systems.
- Keep the battery away from flame and liquid.

## Battery Installation

- Avoid short-circuiting the battery terminals to prevent irreversible damage to the system and battery caused by current bursts.
- Verify polarity before wiring to avoid irreversible battery damage due to polarity reversal. Do not touch the positive and negative terminals of the battery with your hands.
- To ensure safe and reliable operation of the system, 9 N.m torque is recommended when securing cable connections. Over-tightening can result in terminal breakage, while loose connections can lead to terminal meltdown or fire.

## Connect Single Battery

- Step 1** Install the CAN impedance matching connector and identify battery terminal as shown below.

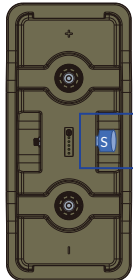

**Step 2** Connect the communication cables and positive / negative cables as shown below.

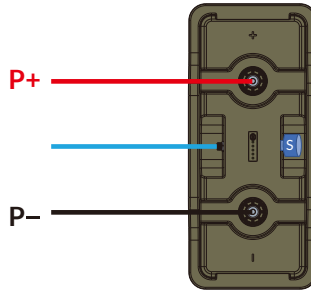

## Connect Batteries in Parallel

**Step 1** Place all batteries as per requirement (Max 8 PCS).

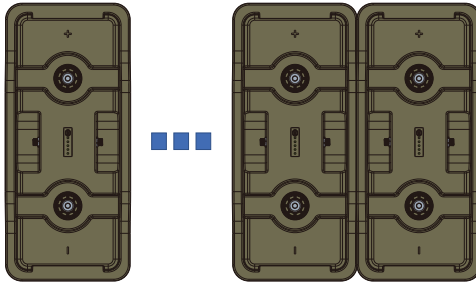

**Step 2** Install the CAN impedance matching connector and identify terminal to the terminal of battery as shown below.

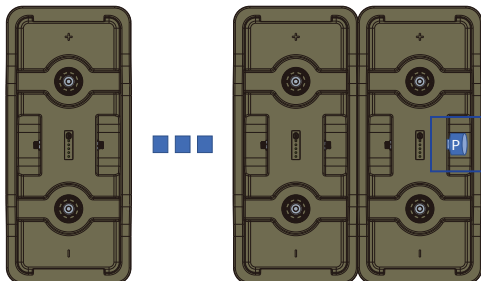

**Step 3** Connect the communication cables as shown below.

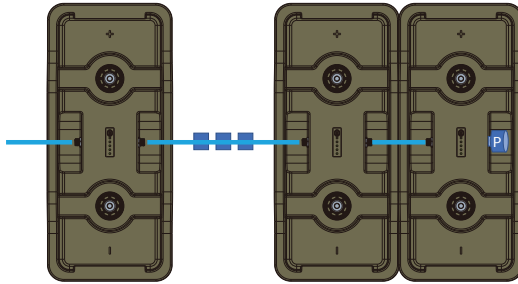

**Step 4** Determine if the communication between the batteries is normal.

1. Description of the button (Key) & display panel (LED).

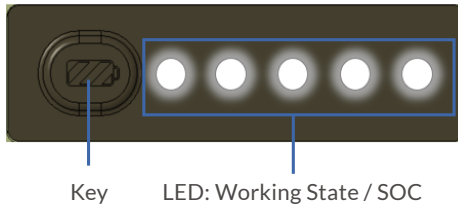

2. Pressing the button of the panel on any of the batteries triggers all batteries to display SOC information.

Normal state: all batteries show their capacity levels (all LEDs light up for 1 second -> LED display according to SOC).

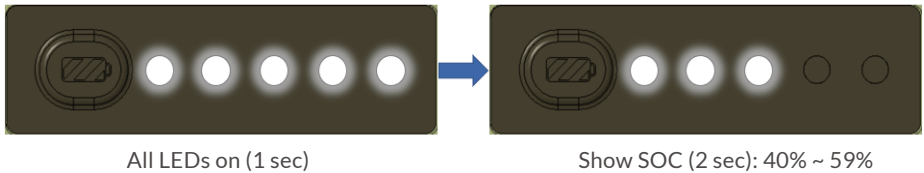

**Step 5** Initiate the setup of battery parallel communication.

1. Trigger the system to assign the communication ID and establish the parallel communication: select any battery (this will be the master) and press the Key button for at least 5 seconds. Release the Key button after the LED enters blinking mode, as shown below.



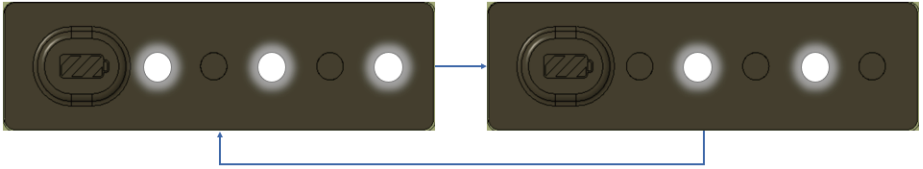

2. Wait for the system to automatically complete the parallel communication establishment operation: all LEDs will flash 3 times to indicate the end of the operation.

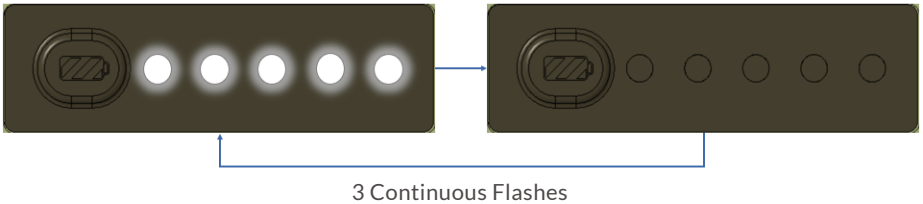

**Step 6** Detect if the parallel communication setting is successful.

Normal State: Only one master battery exists, all others are slave batteries.

See figures below for example of normal working Master and Slave batteries, indicated by their continuous slow blinking LEDs.

Master

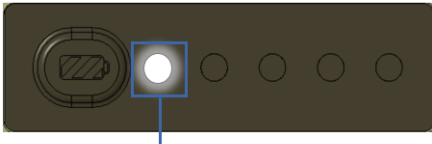

Normal Working State: Slow Flashing Continue  
(on: 1.5 sec, off: 1.5 sec)

Slave

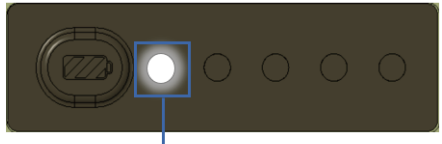

Normal Working State: Slow Flashing Continue  
(on: 0.5 sec, off: 0.5 sec)

**Step 7** Using the positive / negative parallel wires to connect the P+/P- terminal of the batteries together.

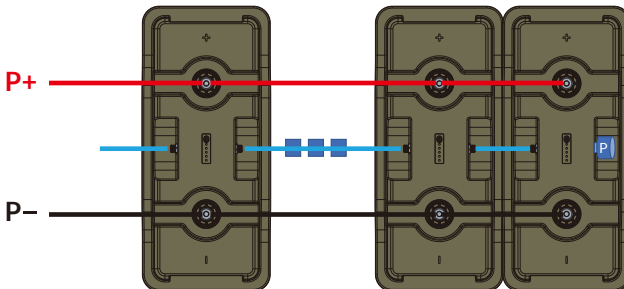

## Connect Batteries in Series

Item	Spec.
Max. Norm. Voltage in Series System	51.2V
Max. Norm. Capacity in Series System	2.56kWh
Max. Cont. Discharge Current in Series System	50A

**Step 1** Place all batteries as per requirement (Max 2 PCS).

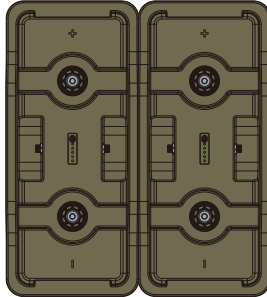

**Step 2** Install the CAN impedance matching connector and identify terminal to the terminal of battery as shown below.

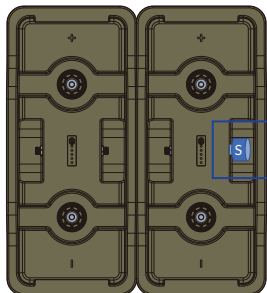

**Step 3** Connect the communication cables as shown below.

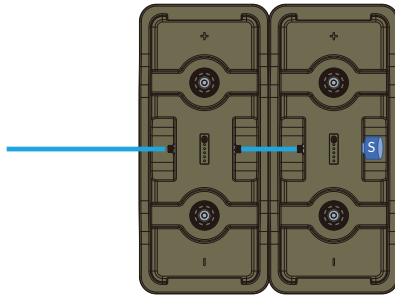

**Step 4** Determine if the communication between the batteries is normal.

1. Description of the button (Key) & display panel (LED).

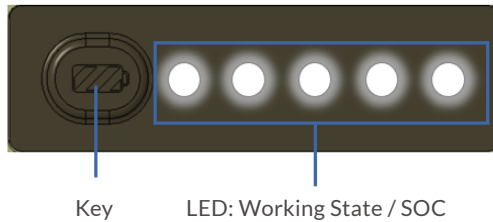

2. Pressing the button of the panel on any of the batteries triggers all batteries to display SOC information.

Normal state: all batteries show their capacity levels (all LEDs light up for 1 second -> LED display value according to SOC).

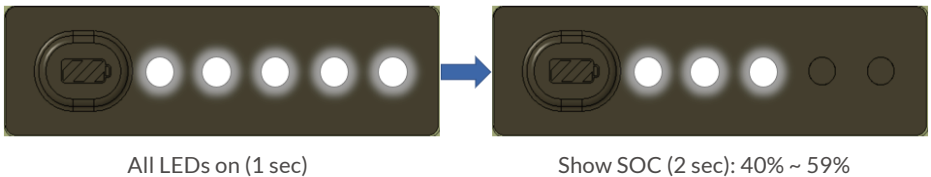

**Step 5** Initiate the setup of battery series communication.

1. Trigger the system to assign the communication ID and establish the series communication: select any battery (this will be the master) and press the Key button for at least 5 seconds. Release the Key button after the LED enters blinking mode, as shown below.

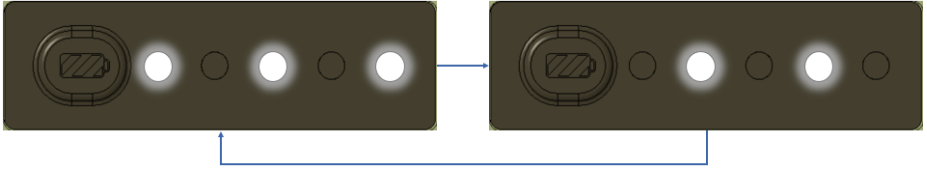

2. Wait for the system to automatically complete the series communication establishment operation: all LEDs will flash 3 times to indicate the end of the operation.

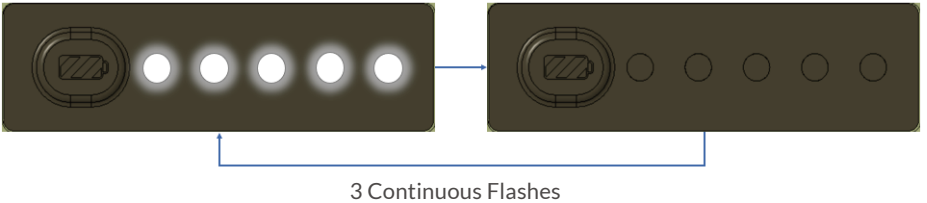

**Step 6** Detect if the series communication setting is successful.

Normal State: Only one master battery exists, all others are slave batteries.

See figures below for example of normal working Master and Slave batteries, indicated by their continuous slow blinking LEDs.

Master

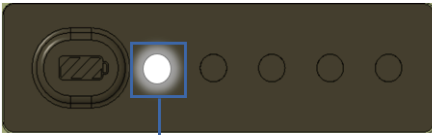

Normal Working State: Slow Flashing Continue  
(on: 3 sec, off: 13 sec)

Slave

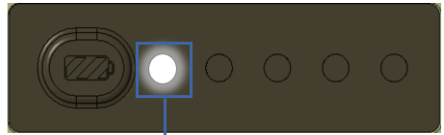

Normal Working State: Slow Flashing Continue  
(on: 0.5 sec, off: 0.5 sec)

**Step 7** Using the positive / negative series harness, connect the P+/P- terminal of the batteries together.

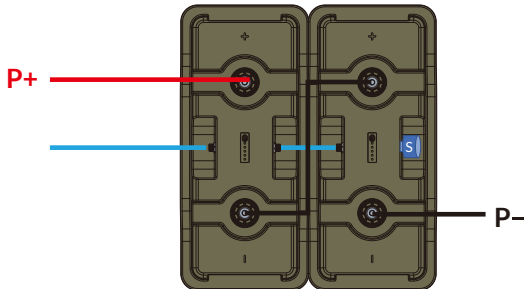

## Select Appropriate Connection Cables

The user should select the appropriate connection cables according to the power of the third-party power system and the discharge current of the battery.

The following table shows the load capacity of different battery connection cables:

Cable Gauge Size	Ampacity	Cable Gauge Size	Ampacity
14 AWG (2.08 mm <sup>2</sup> )	35A	2 AWG (33.6 mm <sup>2</sup> )	190A
12 AWG (3.31 mm <sup>2</sup> )	40A	1 AWG (42.4 mm <sup>2</sup> )	220A
10 AWG (5.25 mm <sup>2</sup> )	55A	1/0 AWG (53.5 mm <sup>2</sup> )	260A
8 AWG (8.36 mm <sup>2</sup> )	80A	2/0 AWG (67.4 mm <sup>2</sup> )	300A
6 AWG (13.3 mm <sup>2</sup> )	105A	4/0 AWG (107 mm <sup>2</sup> )	405A
4 AWG (21.1 mm <sup>2</sup> )	140A	/	/

## Battery SOC Table

The SOC values listed below are estimated based on the open circuit voltage when the battery is at rest for 60 minutes, not in charging or discharging state.

SOC	Open Circuit Voltage	SOC	Open Circuit Voltage
100%	26.70V	35%	26.10V
99%	26.53V	20%	25.74V
90%	26.51V	10%	25.40V
70%	26.40V	5%	24.80V
60%	26.20V	0%	21.36V

## Battery Management System

The battery is equipped with a battery management system (BMS) and has the following battery protection features:

Over-discharge Protection	Prevents Over-discharging of Batteries
Over-charge Protection	Prevents Over-charging of Batteries
Overheat Charging / Discharging Protection	Prevents High Battery Temperature
Over-current Charging / Discharging Protection	Prevents Excessive Battery Current
Battery Balance Function	Keeps Each Individual Cell in the Same Condition to Ensure the Battery is in An Optimal Condition for Use

\*If a protection alert is triggered, completely disconnect the battery and leave it for some time before reconnecting and restarting.

## Self-Heating Function

The normal operation of the self-heating function requires a stable charge current greater than 3A for each battery. The self-heating function will start operating automatically once the battery temperature drops below 19.4°F ( - 7°C) and stop operating automatically once the battery temperature rises above to 41°F ( 5°C).

# Troubleshooting

Description of Error	Error Type	Recovery Methods
The key button switch does not trigger the LED display	Over discharge due to self discharge or hanging load	Please charge the battery immediately
The battery turns off the output during usage and pressing the key button causes only one LED to flash	The battery voltage drops below the protection threshold	Remove the load and charge the battery
Cannot charge below -10 °C	Triggered low-temperature charging protection	Connect the charger Wait for at least 5 ~ 10s The battery will automatically heat up and work, with different waiting times at different temperatures, to reach a temperature of -7°C or above
No output when using in high or low temperature environments	The battery temperature exceeds the threshold value for high or low temperature	Disconnect the battery from the load Let battery cool The battery automatically recovers from high and low temperature protection and continues to operate
Battery short circuit occurs	During usage, the positive and negative poles are at risk of short circuiting	Immediately remove the positive and negative short circuits Wait for 60 seconds for automatic recovery
The load current exceeds 55A, and the battery is not providing any output	Trigger discharge overcurrent protection	Remove the load for recovery or wait for 60 seconds for recovery The load current should be less than 50A
Charging the battery pack with a current greater than 55A damages the battery and prevents it from charging	Trigger charging overcurrent protection	Remove the charger and use a charger with an output current below 50A to charge

## Specifications

Item		Spec.
Nominal Capacity		50Ah
Rated (Min.) Capacity (Cmin)		49Ah
Nominal Voltage		25.6V
Delivery Voltage or SOC		SOC 20% - 30%
Charge Method		CC/CV
Limited Charging Voltage (Ucl)		28.4V
Upper Limited Charging Voltage (Uup)		28.8V
End of Discharge Voltage (Ude)		23.2V
Discharge Cut-off Voltage (Udo)		22.4V
Recommended Charge Current (Icr)		25A
Max. Cont. Charge Current (Icm)		50A
Recommended Discharge Current (Idr)		25A
Max. Cont. Discharge Current (Idm)		50A (125A for 10s)
Operating Temperature	Charge	0°C ~ 45°C
	Discharge	- 20°C ~ 55°C
Operating Humidity		25% ~ 75%
Cycle Life		6000 Cycles (Retention ≥ 70% Cmin)
<p>1 ItA charge to Ucl with end current of 0.05 ItA and discharge at CC of 1 ItA to Udo. Rest interval is 30 min.</p>		
Internal Impedance (AC 1kHz)		≤ 50 mΩ
Weight		12.9 ± 0.1KG
Ingress Protection Grade		IP67
Storage Humidity		25% ~ 50%
Storage Temperature	Within 1 month	- 20°C ~ 55°C
	Within 3 months	- 20°C ~ 30°C
	Within 6 months	20°C ± 5°C



# Battery Maintenance and Disposal

## Maintenance Instructions

- The battery must be stored in a dry and well-ventilated environment away from water sources, heat sources, and metal objects. It is recommended to store the battery at a temperature of 15-25°C (59-77°F). If the storage temperature is too high or too low, this will affect the self-discharge rate of the battery and accelerate the natural aging of the battery.
- If the battery is not going to be used for a long period of time, it is recommended to be stored intact in a semi - charged state (60% SOC). The battery is recommended to be discharged to 30% and then recharged to 60% every three months.
- When the temperature of the battery is equal to or below -20°C (-4°F), the battery cannot be used for charging, discharging or heating.
- If the battery level is below 1% after use, it should be charged to 60% before storage. If the battery is left idle for a long period of time with critically low SOC, irreversible damage to the battery cell will occur, reducing the service life of the battery.
- If the battery SOC is critically low and being left idle for too long, it will enter deep sleep mode and will need to be recharged before it can be used again.

## Disposal

- If conditions permit, make sure that the battery is completely discharged before placing the battery in the designated battery recycling bin. The battery cells, which contain hazardous chemicals, are strictly prohibited from being placed in an ordinary garbage bin. For relevant details, please comply with the user's local laws and regulations regarding lithium battery recycling and disposal.
- If the battery cannot be fully discharged due to the fault of the product itself, do not dispose the battery directly.
- Contact a specialized battery recycling company for further disposal.
- An over-discharged battery cannot be switched on. Please dispose the battery according to local laws and regulations.

## Frequently Asked Questions

### **What type of battery chemistry is used in this product?**

This product uses high quality lithium iron phosphate.

### **How do I clean the battery?**

The battery can be wiped with a dry, soft, and clean cloth or tissue.

### **Are lithium batteries safe?**

TWS's Flexiblock battery is protected by a high-performance BMS and has undergone rigorous testing to ensure safe usage.

### **Can the 5kWh LFP Battery and 2kWh LFP Battery be used in parallel?**

This is not recommended - when using two models in parallel, the consistency of the batteries cannot be guaranteed, which can lead to shortened life span of the batteries or even a safety hazard.

### **Can I charge the battery at low temperature?**

Yes, when the battery is being charged at low temperature  $-20^{\circ}\text{C} \leq T \leq 0^{\circ}\text{C}$  ( $-4^{\circ}\text{F} \leq T \leq 32^{\circ}\text{F}$ ), the charge heating function is switched on prior to heat the battery before it is charged normally.

### **Can the battery be used with third-party power systems?**

Yes, the user will need to perform extra wiring for this.

### **How do I store the battery?**

When storing the battery, first power it off and then store it in a dry, ventilated place at room temperature and stay away from water sources.

## Disclaimer

Please read this User Manual and ensure you understand it fully before using the product. Please keep this User Manual properly for future reference. Any incorrect usage of this product may cause severe injury to the user or others, damage to the product, or loss of property.

By using this product, the user will be deemed as having understood, recognized, and accepted all the terms and contents of this User Manual, and will be responsible for any incorrect usage and all consequences arising therefrom.

TWS Technology hereby disclaims any liability for any losses due to the user's failure to use the product according to the User Manual.

In compliance with laws and regulations, TWS shall have the final right to interpret this document and all related documents for this product. Any update, revision, or termination of the contents thereof, if necessary, shall be made without prior notice, and users may visit TWS official website for the latest information of the product.

**DE**  **ARBONIZED**  
by **TWS**  
Technology with Spirit

Email  
[info.mps@tws.com](mailto:info.mps@tws.com)

Website  
[www.tws.com](http://www.tws.com)

